

Features

- Very Sharp Breakdown Characteristics
- Very Tight Tolerance on V_Z
- Ideally Suited for Automated Assembly Processes
- Very Low Leakage Current
- **Lead Free By Design/RoHS Compliant (Note 1)**
- **“Green” Device (Note 2)**

Mechanical Data

- Case: SOD-323
- Case Material: Molded Plastic, “Green” Molding Compound. UL Flammability Classification Rating 94V-0
- Moisture Sensitivity: Level 1 per J-STD-020
- Terminals: Finish - Matte Tin annealed over Alloy 42 leadframe. Solderable per MIL-STD-202, Method 208
- Polarity: Cathode Band
- Marking Information: See Page 6
- Ordering Information: See Page 6
- Weight: 0.004 grams (approximate)



Top View

Maximum Ratings @ $T_A = 25^\circ\text{C}$ unless otherwise specified

| Characteristic | Symbol | Value | Unit |
|---------------------------------------|--------|-------|------|
| Forward Voltage @ $I_F = 10\text{mA}$ | V_F | 0.9 | V |

Thermal Characteristics

| Characteristic | Symbol | Value | Unit |
|--|-----------------|-------------|--------------------|
| Power Dissipation (Note 3) | P_D | 200 | mW |
| Thermal Resistance, Junction to Ambient Air (Note 3) | $R_{\theta JA}$ | 625 | $^\circ\text{C/W}$ |
| Operating and Storage Temperature Range | T_J, T_{STG} | -65 to +150 | $^\circ\text{C}$ |

- Notes:
1. No purposefully added lead.
 2. Diode's Inc.'s “Green” policy can be found on our website at http://www.diodes.com/products/lead_free/index.php.
 3. Device mounted on FR-4 PC board with recommended pad layout, which can be found on our website at <http://www.diodes.com/datasheets/ap02001.pdf>.

Electrical Characteristics @T_A = 25°C unless otherwise specified

| Type Number | Type Code | Zener Voltage Range (Note 3) | | | | Maximum Reverse Leakage Current (Note 4) | |
|-------------------|-----------|----------------------------------|---------|---------|-----------------|--|------|
| | | V _Z @ I _{ZT} | | | I _{ZT} | I _R @ V _R | |
| | | Nom (V) | Min (V) | Max (V) | μA | μA | V |
| DDZ9689S | HH | 5.1 | 4.85 | 5.36 | 50 | 5 | 3 |
| DDZ9690S | HJ | 5.6 | 5.32 | 5.88 | 50 | 2 | 4 |
| DDZ9691S | HK | 6.2 | 5.89 | 6.51 | 50 | 1 | 5 |
| DDZ9692S | HL | 6.8 | 6.46 | 7.14 | 50 | 0.1 | 5.1 |
| DDZ9693S | HM | 7.5 | 7.13 | 7.88 | 50 | 0.1 | 5.7 |
| DDZ9694S | HN | 8.2 | 7.79 | 8.61 | 50 | 0.1 | 6.2 |
| DDZ9696S | HP | 9.1 | 8.65 | 9.56 | 50 | 0.1 | 6.9 |
| DDZ9697S | HQ | 10 | 9.50 | 10.50 | 50 | 0.1 | 7.6 |
| DDZ9698S | HR | 11 | 10.45 | 11.55 | 50 | 0.05 | 8.4 |
| DDZ9699S | HS | 12 | 11.40 | 12.60 | 50 | 0.05 | 9.1 |
| DDZ9700S | HT | 13 | 12.35 | 13.65 | 50 | 0.05 | 9.8 |
| DDZ9701S | HU | 14 | 13.30 | 14.70 | 50 | 0.05 | 10.6 |
| DDZ9702S | HV | 15 | 14.25 | 15.75 | 50 | 0.05 | 11.4 |
| DDZ9703S | HW | 16 | 15.20 | 16.80 | 50 | 0.05 | 12.1 |
| DDZ9705S (Note 5) | HY | 18 | 17.10 | 18.90 | 50 | 0.05 | 13.6 |
| DDZ9707S | MD | 20 | 19.00 | 21.00 | 50 | 0.05 | 15.2 |
| DDZ9708S | ME | 22 | 20.90 | 23.10 | 50 | 0.05 | 16.7 |
| DDZ9709S | MF | 24 | 22.80 | 25.20 | 50 | 0.05 | 18.2 |
| DDZ9711S | MH | 27 | 25.65 | 28.35 | 50 | 0.05 | 20.4 |
| DDZ9712S | MJ | 28 | 26.60 | 29.40 | 50 | 0.05 | 21.2 |
| DDZ9713S | MK | 30 | 28.50 | 31.50 | 50 | 0.05 | 22.8 |
| DDZ9714S | ML | 33 | 31.35 | 34.65 | 50 | 0.05 | 25.0 |
| DDZ9715S | MM | 36 | 34.20 | 37.80 | 50 | 0.05 | 27.3 |
| DDZ9716S | MN | 39 | 37.05 | 40.95 | 50 | 0.05 | 29.6 |
| DDZ9717S | MO | 43 | 40.85 | 45.15 | 50 | 0.05 | 32.6 |

- Notes:
- Nominal Zener voltage is measured with the device junction in thermal equilibrium at T_T = 30°C ±1°C.
 - Short duration pulse test used to minimize self-heating effect.
 - Qualified to AEC-Q101 Standards for High Reliability

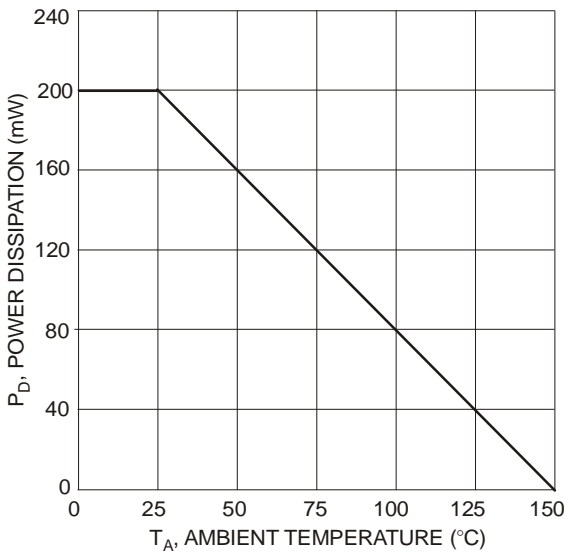

Fig. 1 Power Derating Curve

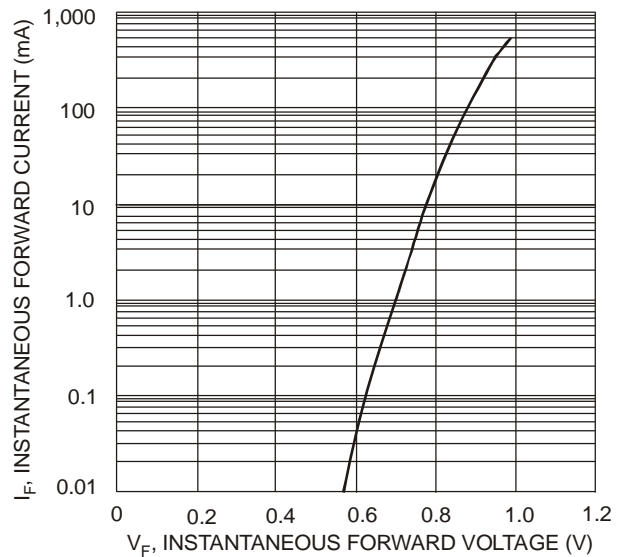

Fig. 2 Typical Forward Characteristics

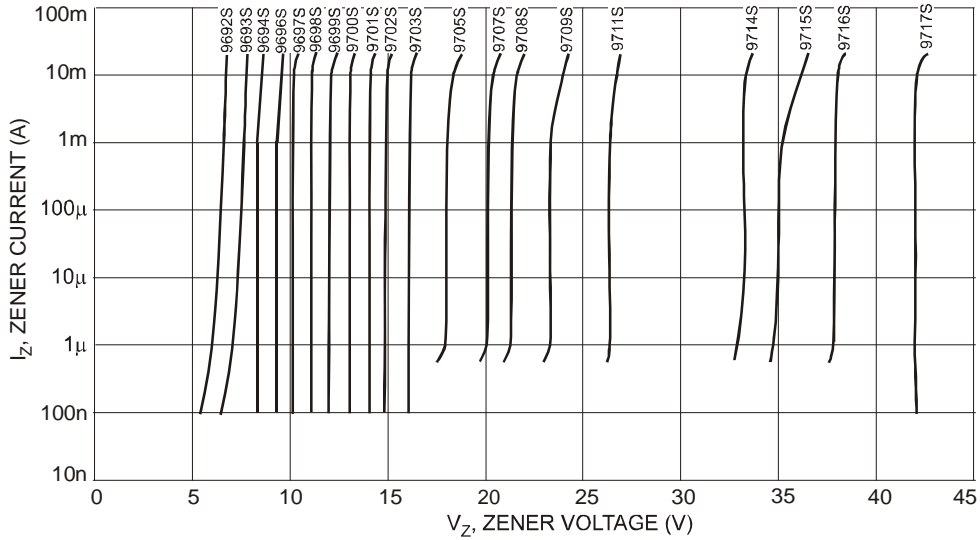

Fig. 3 Typical Zener Breakdown Characteristics

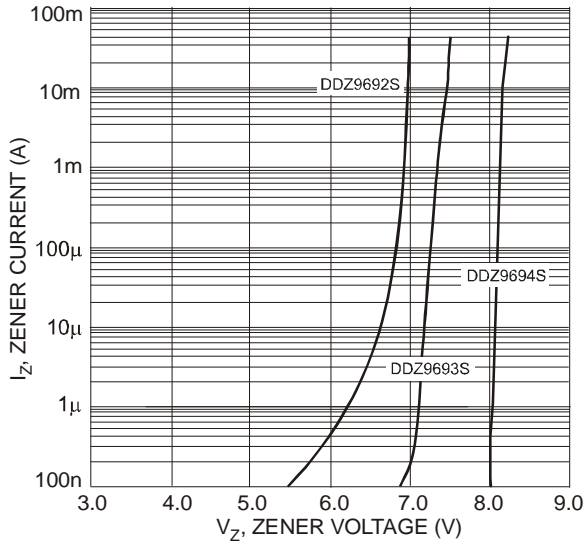

Fig. 4 Typical Zener Breakdown Characteristics, DDZ9692S - DDZ9694S

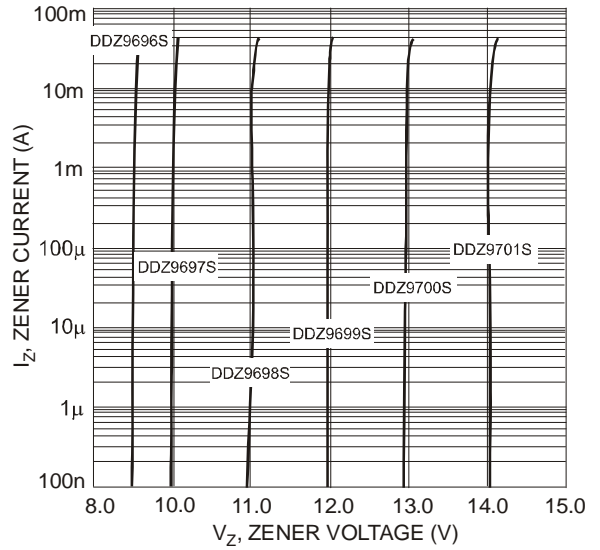

Fig. 5 Typical Zener Breakdown Characteristics, DDZ9696S - DDZ9701S

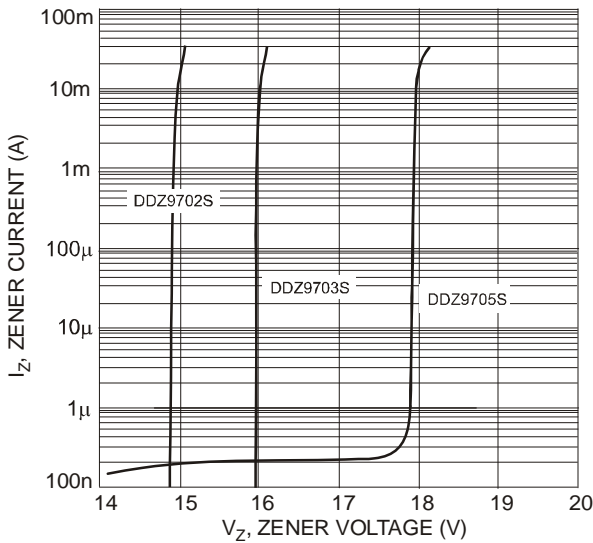

Fig. 6 Typical Zener Breakdown Characteristics, DDZ9702S - DDZ9705S

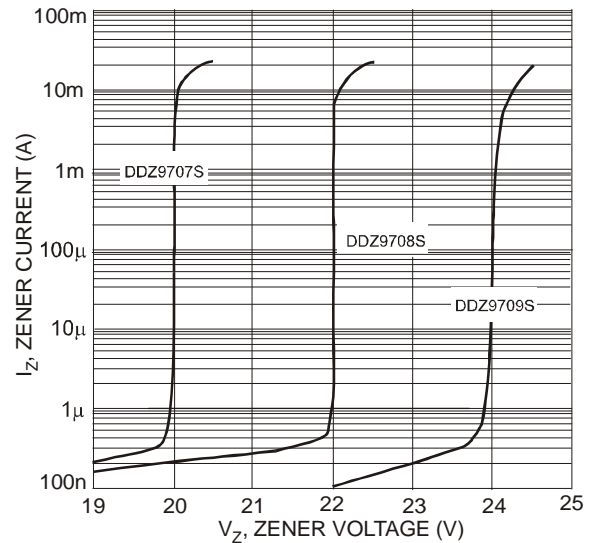

Fig. 7 Typical Zener Breakdown Characteristics, DDZ9707S - DDZ9709S

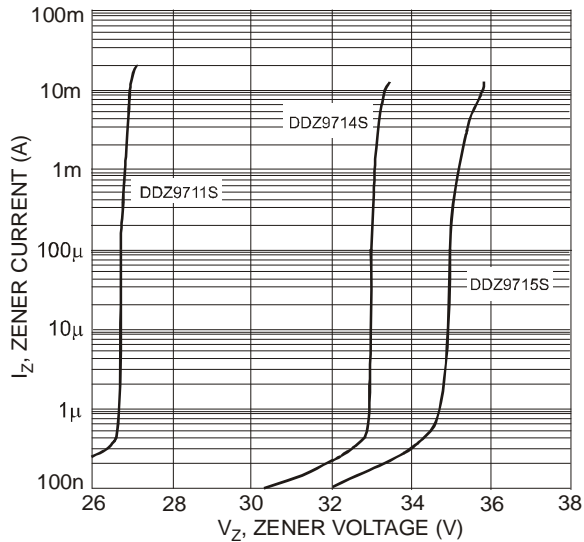

Fig. 8 Typical Zener Breakdown Characteristics, DDZ9711S - DDZ9715S

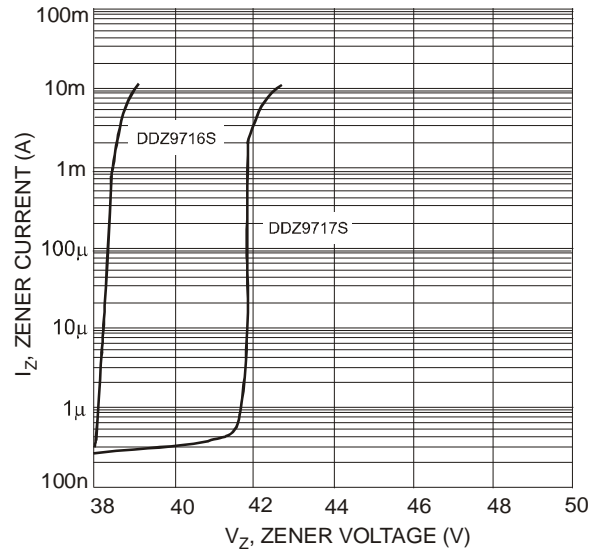

Fig. 9 Typical Zener Breakdown Characteristics, DDZ9716S - DDZ9717S

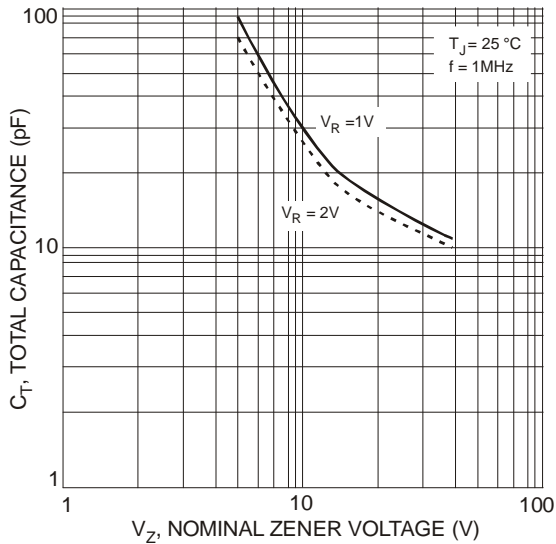

Fig. 10 Total Capacitance vs. Nominal Zener Voltage

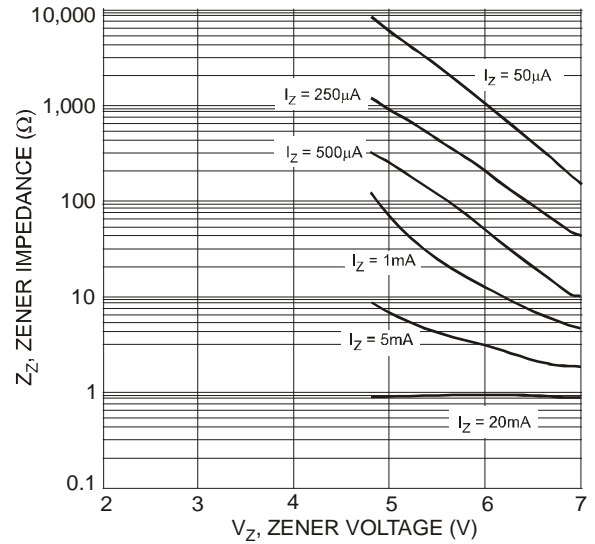

Fig. 11 Typical Zener Impedance Characteristics, DDZ9689S - DDZ9692S

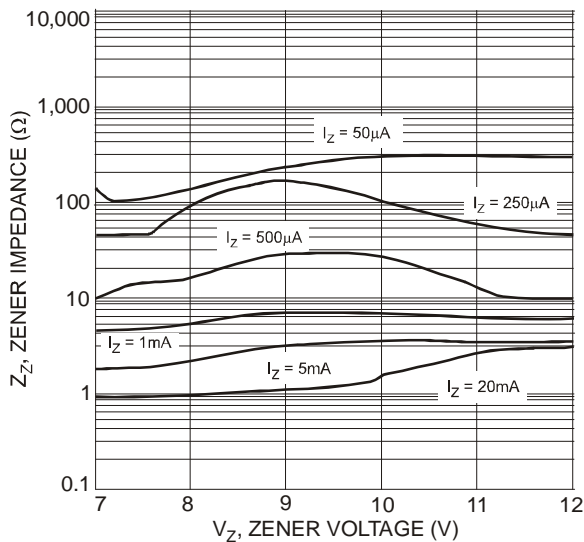

Fig. 12 Typical Zener Impedance Characteristics, DDZ9693S - DDZ9699S

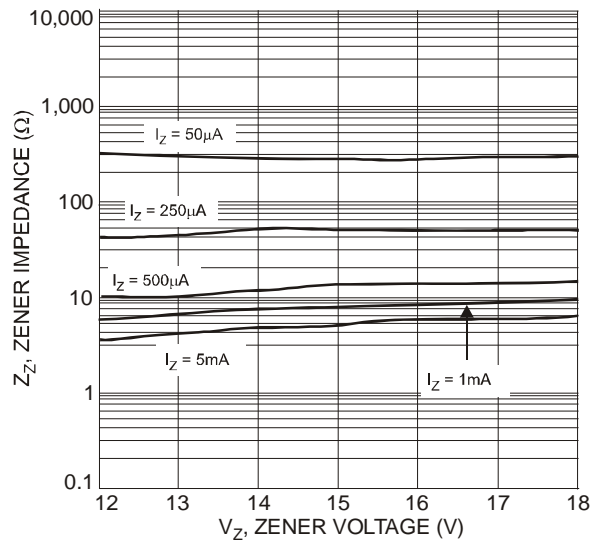

Fig. 13 Typical Zener Impedance Characteristics, DDZ9699S - DDZ9705S

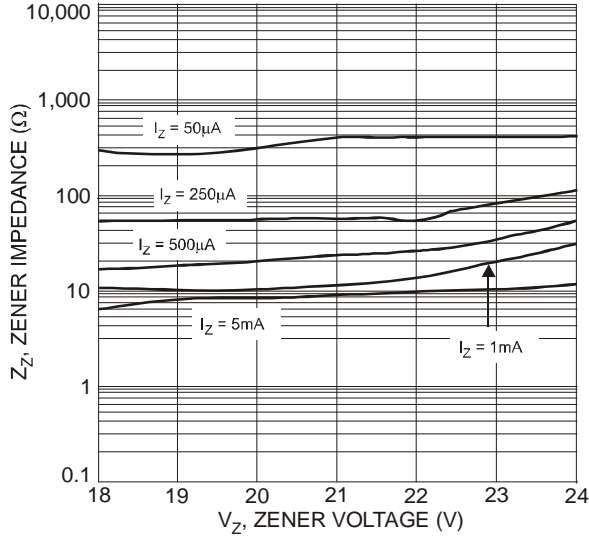

Fig. 14 Typical Zener Impedance Characteristics, DDZ9705S - DDZ9709S

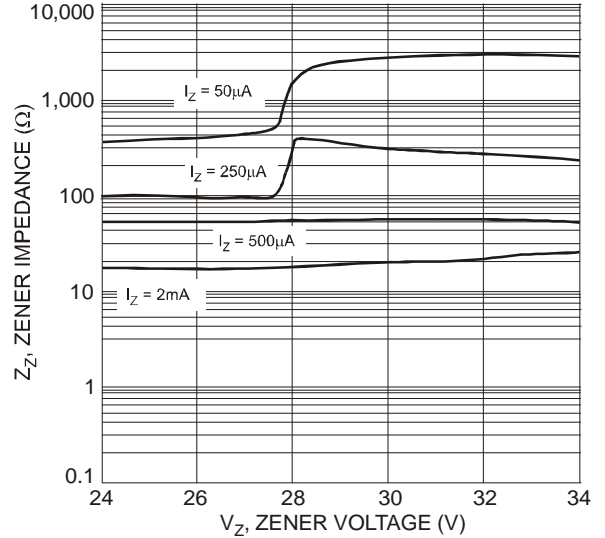

Fig. 15 Typical Zener Impedance Characteristics, DDZ9709S - DDZ9714S

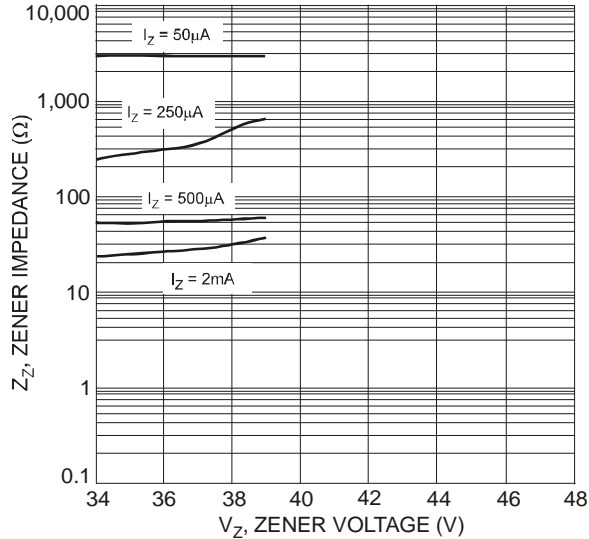

Fig. 16 Typical Zener Impedance Characteristics, DDZ9715S - DDZ9716S

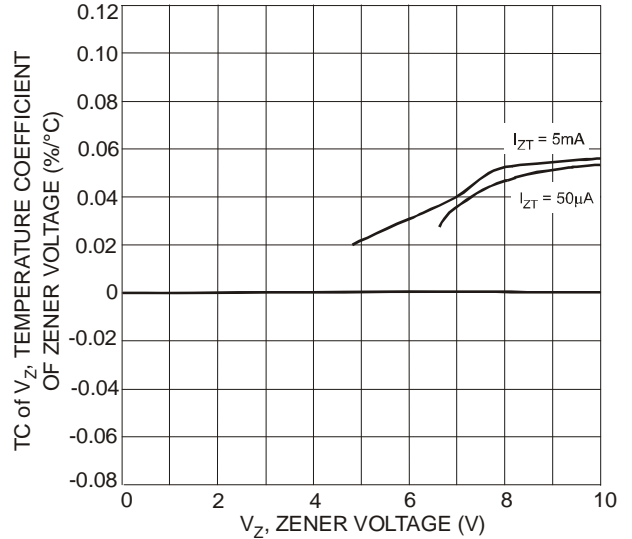

Fig. 17 Typical Temperature Coefficient of Zener Voltage vs. Zener Voltage, DDZ9692S - DDZ9697S

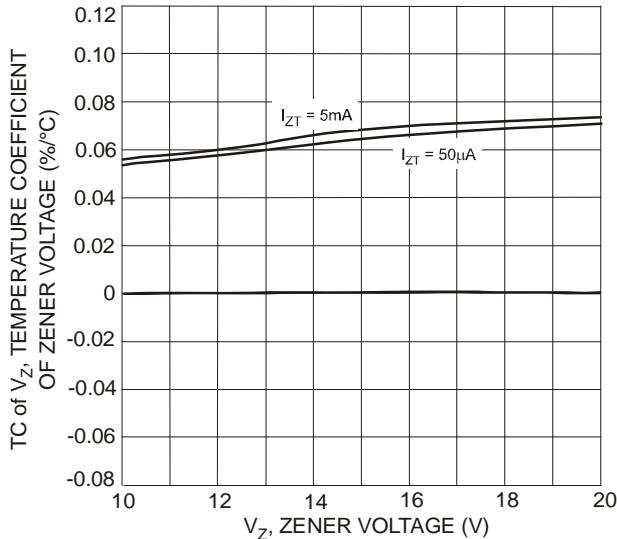

Fig. 18 Typical Temperature Coefficient of Zener Voltage vs. Zener Voltage, DDZ9697S - DDZ9707S

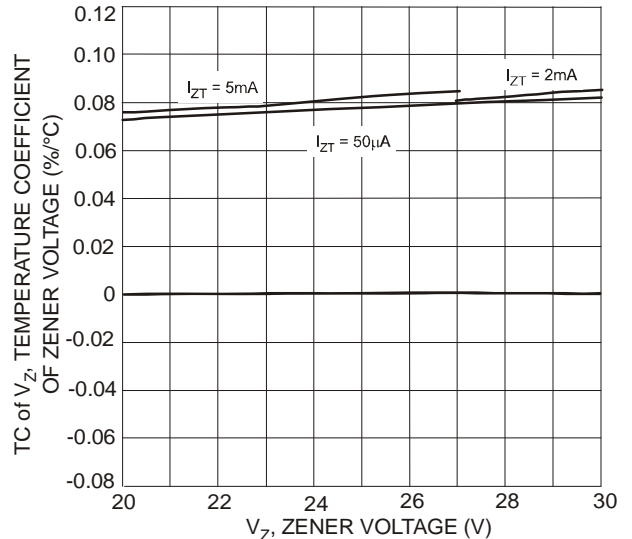

Fig. 19 Typical Temperature Coefficient of Zener Voltage vs. Zener Voltage, DDZ9707S - DDZ9713S

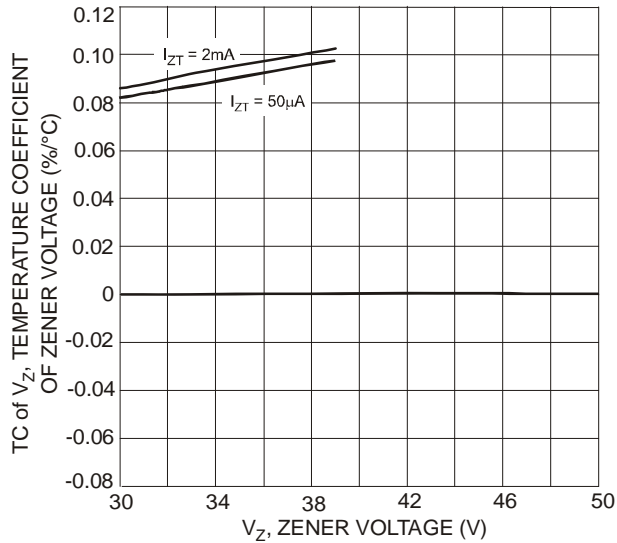

Fig. 20 Typical Temperature Coefficient of Zener Voltage vs. Zener Voltage, DDZ9713S - DDZ9716S

Ordering Information (Note 6)

| Part Number | Case | Packaging |
|------------------|---------|------------------|
| (Type Number)-7* | SOD-323 | 3000/Tape & Reel |

*Example: The part number for the 6.2 Volt device would be DDZ9691S-7.

Notes: 6. For packaging details, go to our website at <http://www.diodes.com/datasheets/ap02007.pdf>.

Marking Information



xx = Product Type Marking Code
(See Electrical Characteristics Table)

Package Outline Dimensions

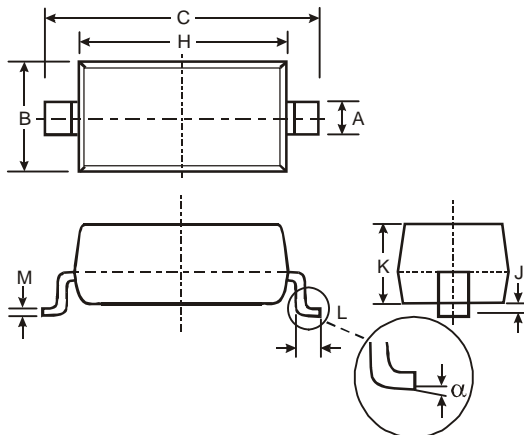

| SOD-323 | | |
|----------------------|------|------|
| Dim | Min | Max |
| A | 0.25 | 0.35 |
| B | 1.20 | 1.40 |
| C | 2.30 | 2.70 |
| H | 1.60 | 1.80 |
| J | 0.00 | 0.10 |
| K | 1.0 | 1.1 |
| L | 0.20 | 0.40 |
| M | 0.10 | 0.15 |
| α | 0° | 8° |
| All Dimensions in mm | | |

Suggested Pad Layout

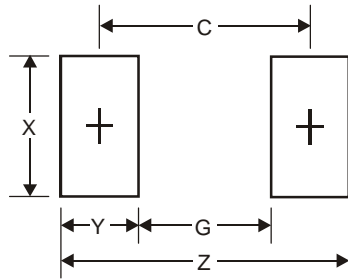

| Dimensions | Value (in mm) |
|------------|---------------|
| Z | 3.75 |
| G | 1.05 |
| X | 0.65 |
| Y | 1.35 |
| C | 2.40 |

IMPORTANT NOTICE

DIODES INCORPORATED MAKES NO WARRANTY OF ANY KIND, EXPRESS OR IMPLIED, WITH REGARDS TO THIS DOCUMENT, INCLUDING, BUT NOT LIMITED TO, THE IMPLIED WARRANTIES OF MERCHANTABILITY AND FITNESS FOR A PARTICULAR PURPOSE (AND THEIR EQUIVALENTS UNDER THE LAWS OF ANY JURISDICTION).

Diodes Incorporated and its subsidiaries reserve the right to make modifications, enhancements, improvements, corrections or other changes without further notice to this document and any product described herein. Diodes Incorporated does not assume any liability arising out of the application or use of this document or any product described herein; neither does Diodes Incorporated convey any license under its patent or trademark rights, nor the rights of others. Any Customer or user of this document or products described herein in such applications shall assume all risks of such use and will agree to hold Diodes Incorporated and all the companies whose products are represented on Diodes Incorporated website, harmless against all damages.

Diodes Incorporated does not warrant or accept any liability whatsoever in respect of any products purchased through unauthorized sales channel. Should Customers purchase or use Diodes Incorporated products for any unintended or unauthorized application, Customers shall indemnify and hold Diodes Incorporated and its representatives harmless against all claims, damages, expenses, and attorney fees arising out of, directly or indirectly, any claim of personal injury or death associated with such unintended or unauthorized application.

Products described herein may be covered by one or more United States, international or foreign patents pending. Product names and markings noted herein may also be covered by one or more United States, international or foreign trademarks.

LIFE SUPPORT

Diodes Incorporated products are specifically not authorized for use as critical components in life support devices or systems without the express written approval of the Chief Executive Officer of Diodes Incorporated. As used herein:

A. Life support devices or systems are devices or systems which:

1. are intended to implant into the body, or
2. support or sustain life and whose failure to perform when properly used in accordance with instructions for use provided in the labeling can be reasonably expected to result in significant injury to the user.

B. A critical component is any component in a life support device or system whose failure to perform can be reasonably expected to cause the failure of the life support device or to affect its safety or effectiveness.

Customers represent that they have all necessary expertise in the safety and regulatory ramifications of their life support devices or systems, and acknowledge and agree that they are solely responsible for all legal, regulatory and safety-related requirements concerning their products and any use of Diodes Incorporated products in such safety-critical, life support devices or systems, notwithstanding any devices- or systems-related information or support that may be provided by Diodes Incorporated. Further, Customers must fully indemnify Diodes Incorporated and its representatives against any damages arising out of the use of Diodes Incorporated products in such safety-critical, life support devices or systems.

Copyright © 2009, Diodes Incorporated

www.diodes.com